

THE HORIZON IRMS: NITROGEN AND CARBON ANALYSIS BY EA-IRMS

INTRODUCTION

The measurement of carbon and nitrogen stable isotope ratios using an elemental analyser coupled to a stable isotope ratio mass spectrometer (IRMS) has for many years proved to be a robust and routine analytical tool across a wide range of applications. Here we present the $\delta^{15}\text{N}$ and $\delta^{13}\text{C}$ results obtained from two different experiments using the Horizon IRMS interfaced to a EuroVector EURO EA 3000 elemental analyser.



Instrumentation

The Horizon IRMS from Nu Instruments is designed for flexibility, reliability and high performance operation, with user friendly instrument control and data analysis software. This next generation instrument possesses unique features for Continuous Flow (CF) analysis, interfacing to a wide range of sample preparation peripherals. The analyser is differentially pumped and incorporates Nu Instruments unique patented zoom optic system.

EuroVector design, manufacture and sell elemental analysers for CHNS-O determination in a wide variety of applications. The EA3000 Series is the comprehensive answer to EA combustion and pyrolysis applications.

Figure 1: Outline schematic of NC set up

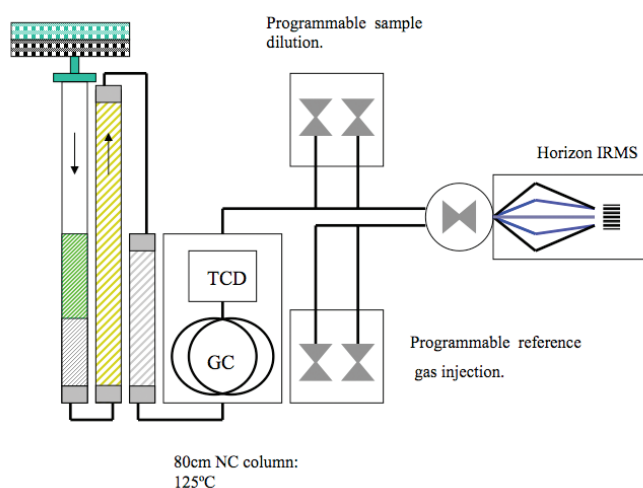

Experiment

EuroVector EURO EA 3000 was configured for standard NC operation and interfaced to the Nu Horizon in CF mode.

Samples dropped into the oxidation reactor of Figure 1 in the presence of oxygen immediately combust to form CO_2 , NO_x and H_2O . These product gases then pass through the reduction reactor where the NO_x is completely converted to N_2 , followed by the chemical water trap where H_2O is removed. The CO_2 and N_2 are then separated spatially in time by the GC column, sampled by the open split interface, and analysed for isotopic composition by the Horizon IRMS.

In Experiment 1, homogenous, finely powdered samples of whale baleen keratin of varying sample size were weighed into tin cups (6 mm x 4 mm) and analysed sequentially for both $\delta^{15}\text{N}$ and $\delta^{13}\text{C}$ values.

In Experiment 2 a wide range of different sample types, pre-weighed into tin capsules, were analysed.

Discussion

Samples typically contain more carbon than nitrogen so the sample size is generally set to give optimum nitrogen performance. For samples containing a low concentration of nitrogen and a high C:N ratio very large quantities of CO₂ are generated, so a programmable dilution is applied prior to sampling by the IRMS.

The integrated sample peak areas are compared isotopically to reference gas peaks that are introduced into the Horizon ion source by the fully programmable reference gas injection system.

Automatic peak centring for both N₂ and CO₂ is available if the user wishes, ensuring optimal analysis conditions for each sample. This can be particularly useful if laboratory conditions (e.g. temperature) vary over the course of a long batch (see Figure 2).

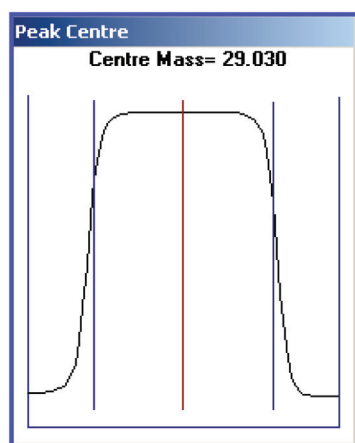

Figure 2: Auto peak centre

At the start of the analysis the user may define automatic peak centring for none, all, or every *n*th sample. The peak centre routine takes 20 seconds in total.

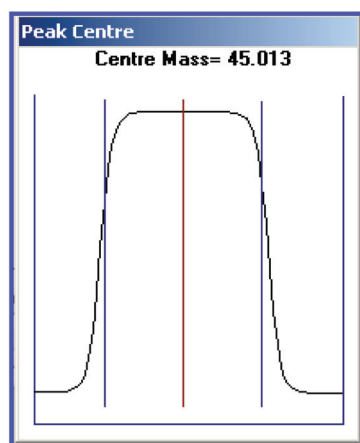
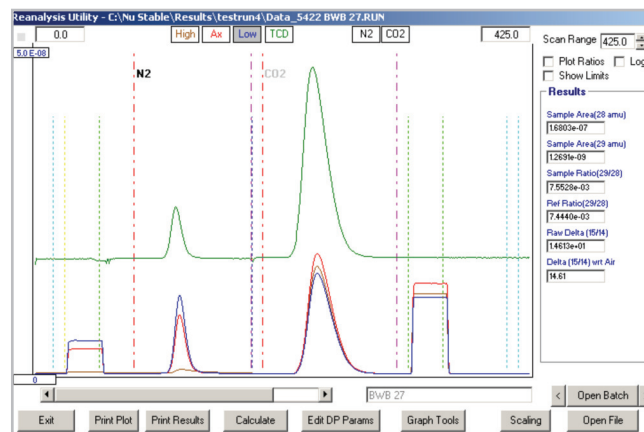

Figure 3 shows a typical chromatogram obtained for the full analytical cycle. The lower trace shows the IRMS output of the reference and sample peaks of N₂ followed later by the sample and reference peaks for CO₂. The upper green trace shows the elemental analyser TCD output.

Figure 3: Analysis chromatogram



The elemental analyser settings used in the generation of the above chromatogram are shown in Table I.

Combustion temp	1030°C
Reduction temp	650°C
Helium flow rate	100ml min ⁻¹
Oxygen amount	15ml
GC oven temp	125°C

Table I:
Elemental analyser settings

Conclusions

A Nu Instruments Horizon IRMS was interfaced with a EuroVector EURO EA 3000 elemental analyser and fitted with a zero blank Vector SAS 80 position autosampler. The system was used to produce data sets from two different experiments, the results of which are shown in the following pages.

Excellent stability, linearity and precision over a 60 fold range in sample amount for both ¹⁵N and ¹³C was demonstrated.

The Horizon IRMS achieves linearity specification better than 0.02‰ / nA across the full range of the 50V amplifiers for both N₂ and CO₂.

The dilutor system for CO₂ has been applied to all the analyses and even the results for samples containing very small quantities of carbon (15 μg C) were unaffected by its use.

Conclusions

We would like to thank the following for help in the production of this data:

Len Wassenaar and Geoff Koehler (NHRC Saskatoon) for providing the whale baleen (keratin) sample;

Paul Brooks (U.C. Berkeley) for provision of the U.C. Berkeley samples and also for extremely helpful discussions and advice on post analysis correction strategies, with particular emphasis on the Fry Mixing Model¹.

¹Fry, Brian, Willi Brand, F. J. Mersch, K. Tholke, and R. Garritt. 1992. Anal. Chem. 64, 288-291.

Experiment I: Whale baleen samples (source NHRC Saskatoon)

$\delta^{15}\text{N}$ data

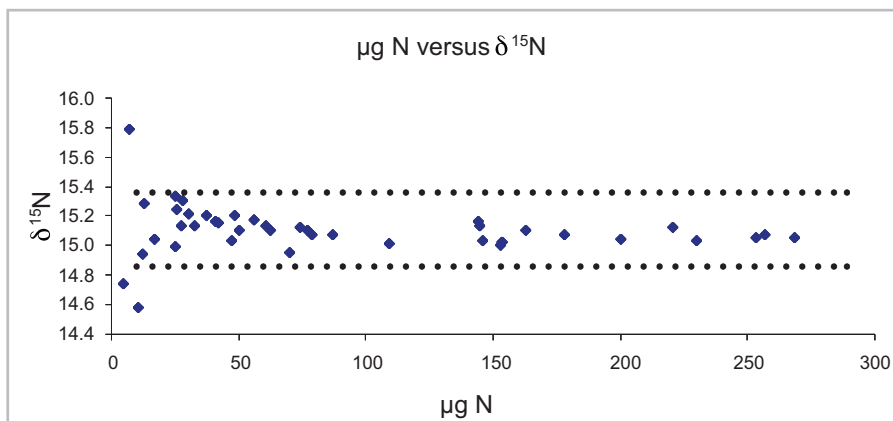

Figure 4:

Linearity of the $\delta^{15}\text{N}$ measurement of whale baleen over a size range of 5-268 $\mu\text{g N}$.

$\delta^{13}\text{C}$ data

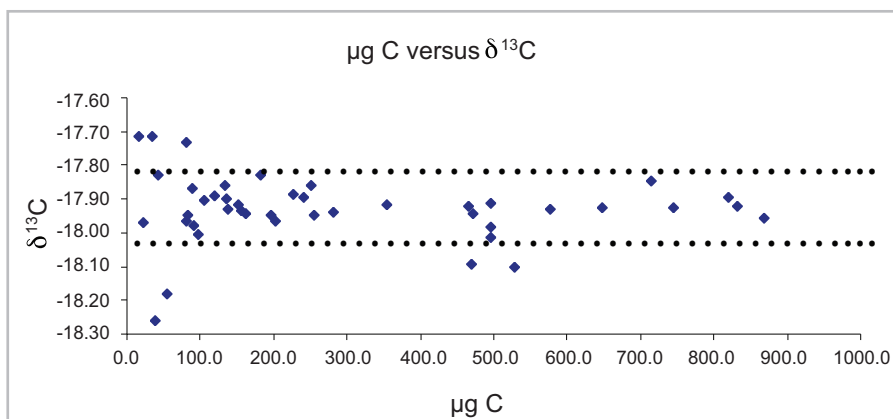

Figure 5:

Linearity of the $\delta^{13}\text{C}$ measurement of whale baleen over a size range of 15-866 $\mu\text{g C}$.

Note that all the samples from the smallest to the largest were subject to the same dilution factor of 5:1

Sample	$\mu\text{g N}$	$\delta^{15}\text{N}$	σ_n	$\mu\text{g C}$	$\delta^{13}\text{C}$	σ_n	n
Whale baleen	All samples 5 - 268	15.10	0.17	All samples 15 - 866	-17.93	0.1	42
	> 10	15.11	0.12				40

Table 2:

Summary of whale baleen analysis.

Experiment 2: Pre-weighed samples (source U.C. Berkeley)

A set of pre-weighed samples covering a range of sizes and materials provided by U.C. Berkeley were analysed for $\delta^{15}\text{N}$ and $\delta^{13}\text{C}$.

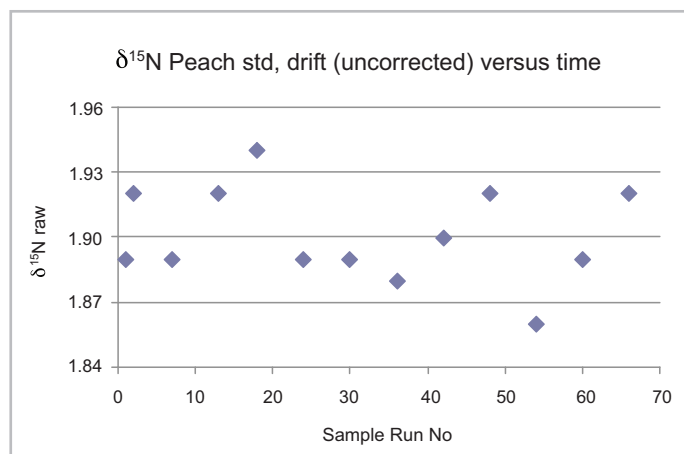

Figure 6:

Graph showing the complete absence of drift in the peach std $\delta^{15}\text{N}$ values.

13 samples of peach leaves of approximately the same weight were interspersed evenly throughout the run.

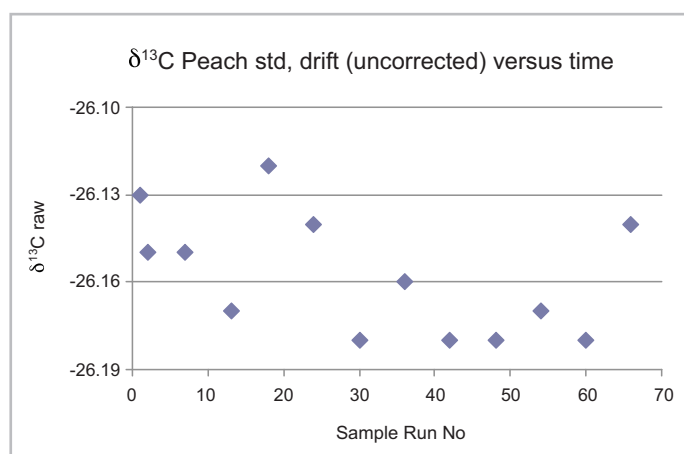

Figure 7:

Graph showing the complete absence of drift in the peach std $\delta^{13}\text{C}$ values.

Sample	$\mu\text{g N}$	$\delta^{15}\text{N}$	σ_n	$\mu\text{g C}$	$\delta^{13}\text{C}$	σ_n	n
Peach std	120	2.04	0.02	1858	-26.02	0.02	13
Peach samples	All samples 5 - 290	2.07	0.15	All samples 71-4232	-26.05	0.04	38
All Peach	> 10	2.07	0.07				46
	5 - 10	2.10	0.42				5
Bovine liver	110 - 284	7.42	0.06	511 - 1302	-21.59	0.02	4
Corn flour	12 - 94	7.42	0.21	420 - 3157	-11.78	0.02	7
Atropine	21 - 127	-19.77	0.22	315 - 1764	-28.65	0.03	7

Table 3:

Results summary for the U.C. Berkeley samples.